

PROFILE VIEW

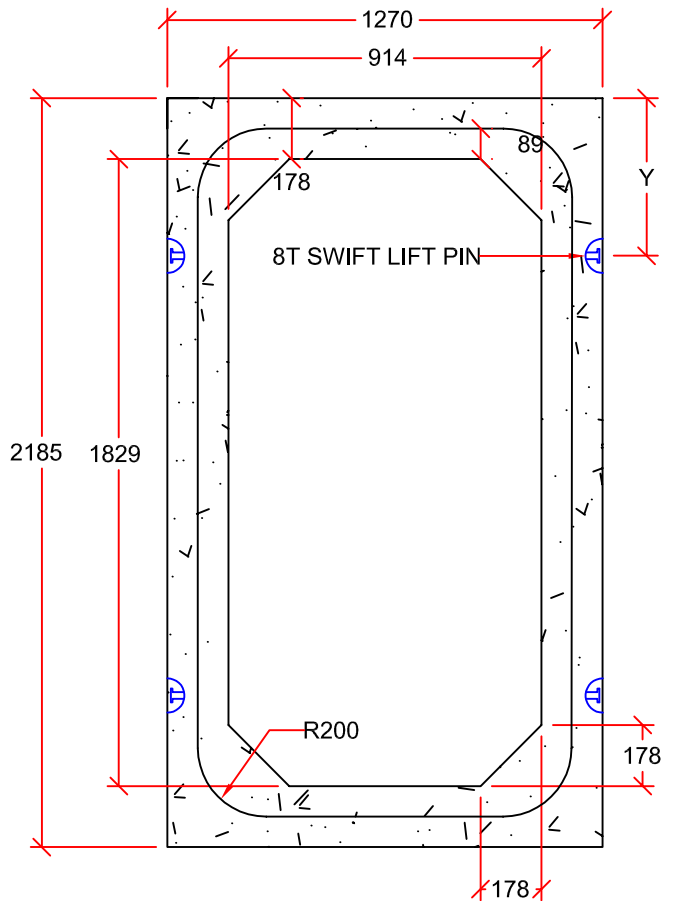

CROSS-SECTION

HORIZONTAL INSTALLATION
VERTICAL INSTALLATION

BOXES AVAILABLE IN 0.6m, 1.2m, 1.5m, 1.8m, 2.0m,
AND 2.5m LENGTHS

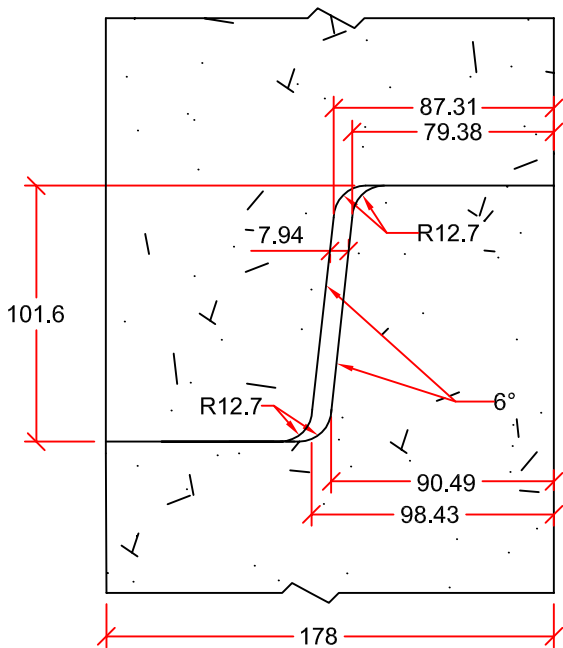

JOINT DETAIL

HEIGHT(H) (mm)	APPROX. MASS (kg)	NUMBER OF PINS	LOAD RATING	X (mm)	Y (mm)
600	1800	2	8T	300	460
1200	3600	4	8T	460	460
1500	4500	4	8T	460	460
1800	5400	4	8T	460	460
2000	6000	4	8T	460	460
2500	7500	4	8T	460	460

DRAWN BY:	KIM PHAM
SCALE:	NTS
DATE:	NOV. 12, 2015
DRAWING #:	1800mm x 900mm BOX
REVISION #:	REV. 1
CHECKED BY:	TYSON DYCK

1800mm x 900mm BOX

DIMENSIONS IN mm. FOR VERTICAL INSTALLATION, 2 SWIFT LIFT PINS ON OPPOSITE SIDES. FOR HORIZONTAL INSTALLATION, 4 SWIFT LIFT PINS ON THE SAME SIDE. STEPS AVAILABLE FOR VERTICAL INSTALLATION.



9265 OAK ST. VANCOUVER B.C.
PH: 604 269-6700 FAX: 604 261-6751