

**MAXIMUM PIPE SIZE FOR
STRAIGHT THROUGH
INSTALLATION**

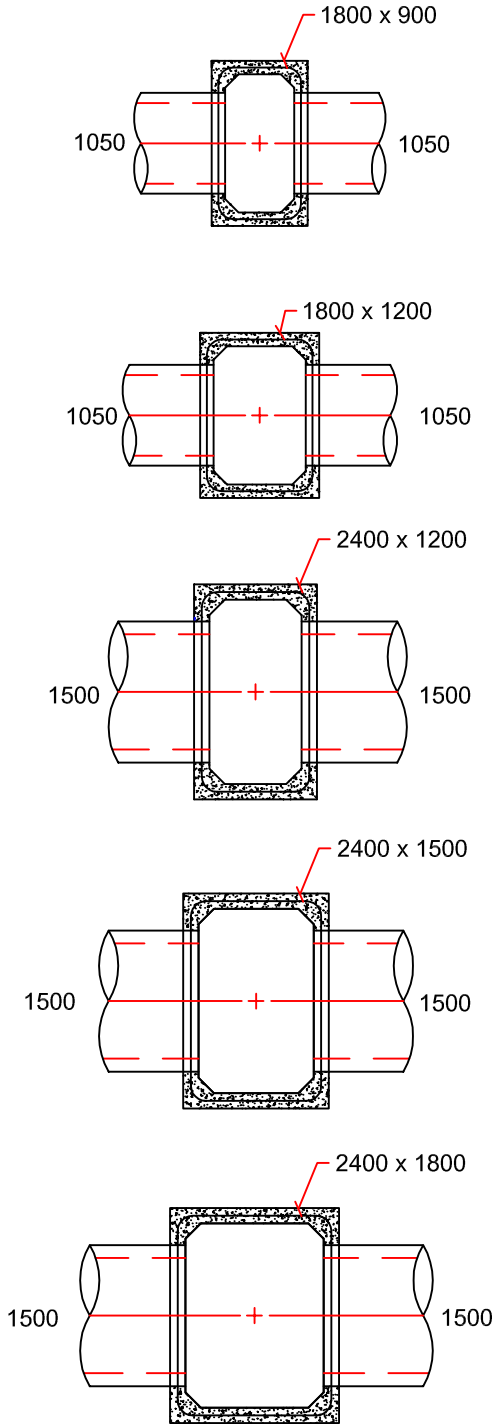

**MAXIMUM PIPE SIZE FOR RIGHT
ANGLE INSTALLATION**

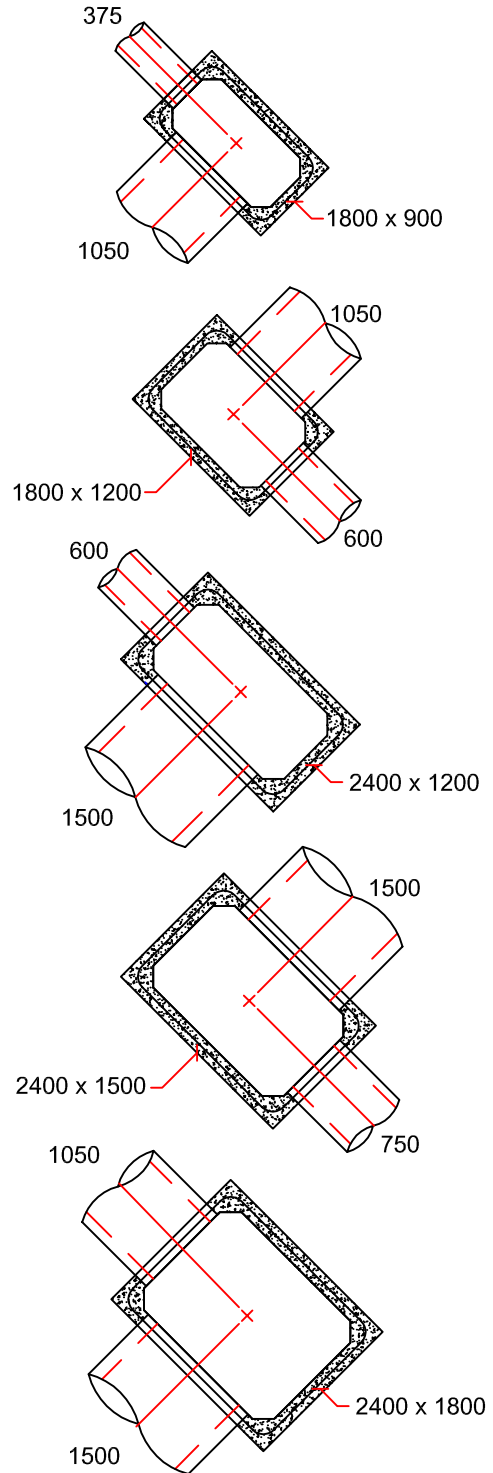

DRAWN BY:	KIM PHAM	<p>MAXIMUM PIPE SIZES FOR BOX SECTIONS</p> <p>ALL DIMENSIONS ARE FOR CONCRETE PIPE AND ARE IN mm. NON-STANDARD ANGLES POSSIBLE, CALL FOR SPECIFIC PROJECT SITUATIONS.</p>	<p>INLAND Pipe</p> <p>7336 112th AVE NW. CALGARY, AB. PH. 403-2795531 FAX: 403-279-7648</p>
SCALE:	NTS		
DATE:	NOVEMBER 18, 2014		
DRAWING #:	MAX-PIPE-SIZE-FOR-BOX-MH1		
REVISION #:	Rev. 1		
CHECKED BY:	TYSON DYCK		