

CAP

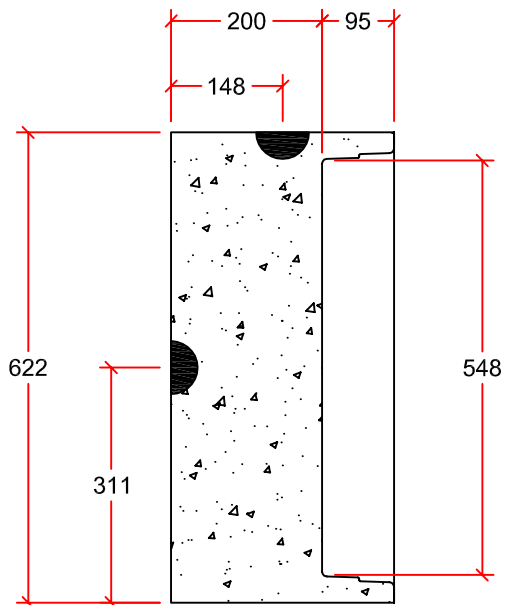

PROFILE VIEW

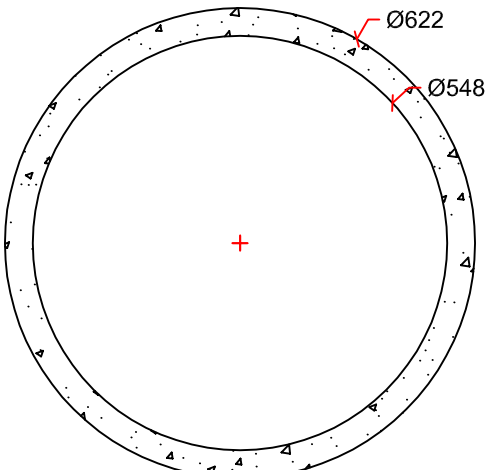

SECTION DETAIL

PLUG

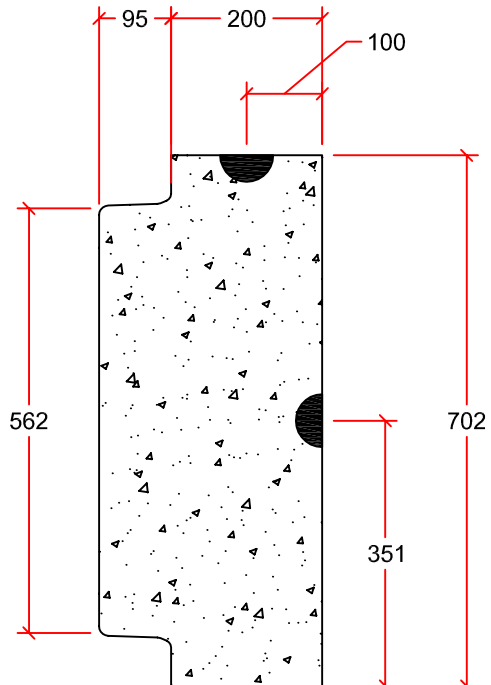

PROFILE VIEW

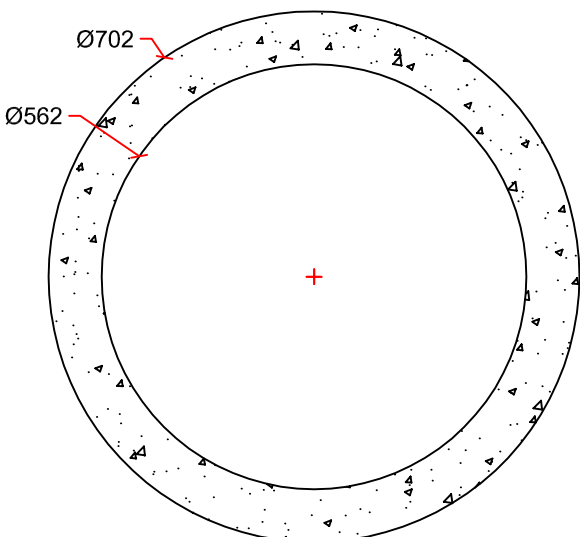

SECTION DETAIL

ADAPTORS

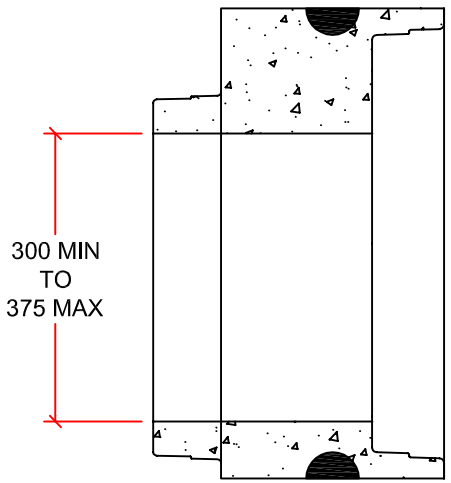

DECREASER

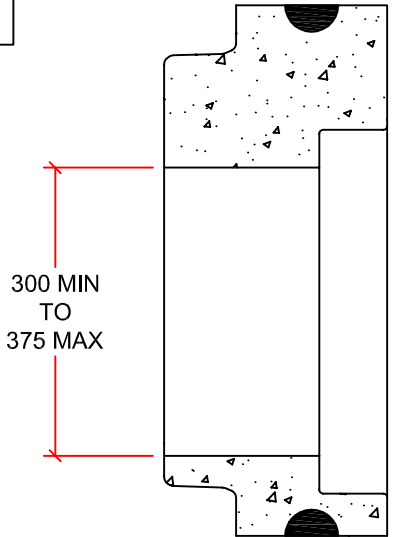

INCREASER

DRAWN BY:	LUCAS STEFAN	Ø450mm PCA (SAB)	INLAND Pipe 7336 112th AVE. NW. CALGARY, AB. PH: 403 279-5531 FAX: 403 279-7648
SCALE:	NTS		
DATE:	NOVEMBER 16, 2015	(2) 4T SWIFT LIFTS ON EACH	
DRAWING #:	Ø450 PCA (SAB)	APPROX. MASS: CAP:162 kg PLUG:243kg	
REVISION #:	REV. 1	DIMENSIONS IN mm	
CHECKED BY:	TYSON DYCK		