

CROSS SECTION

Ø14mm HOLES IN FORM FOR GRATE PINS (3 REQ'D)

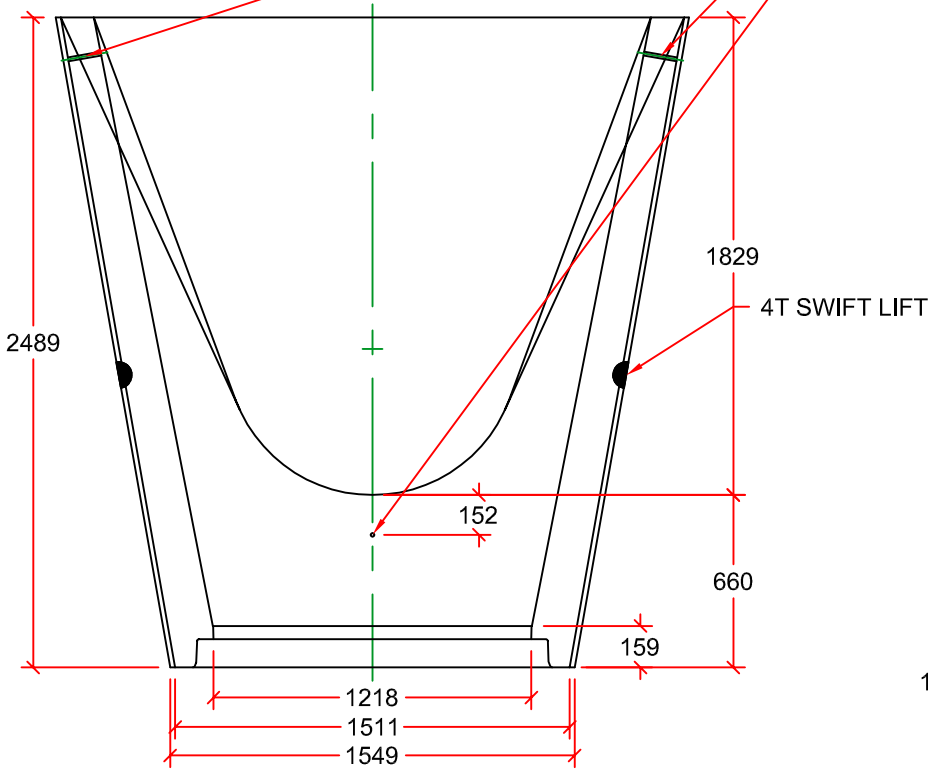

OUTLET SECTION

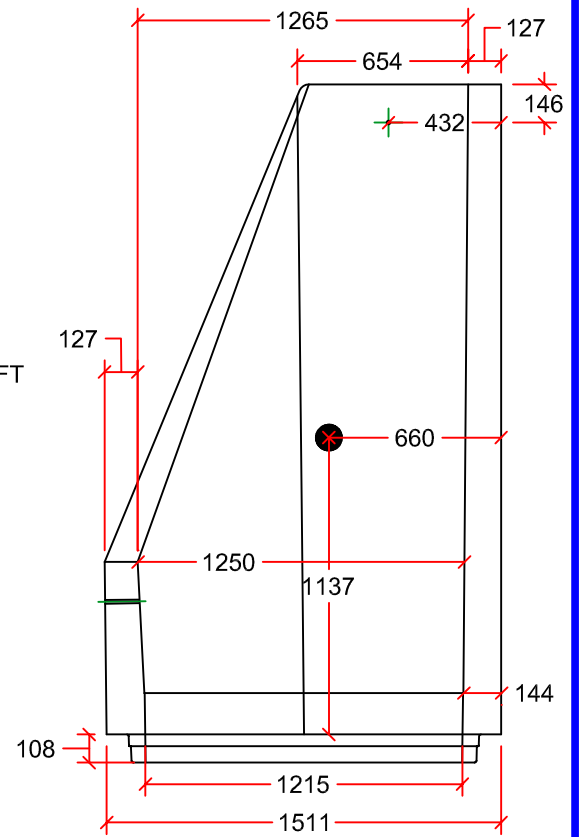

INLET SECTION

DRAWN BY:	LUCAS STEFAN	Ø1200mm FLARED END	
SCALE:	NTS		
DATE:	NOVEMBER 4, 2015	(2) 4T LIFTING PINS ON SIDES APPROXIMATE MASS: 4,490 kg DIMENSIONS IN mm	
DRAWING #:	Ø1200mm FLARED END		
REVISION #:	REV. 1		
CHECKED BY:	TYSON DYCK	7336 112th AVE. NW. CALGARY, AB. PH: 403 279-5531 FAX: 403 279-7648	