

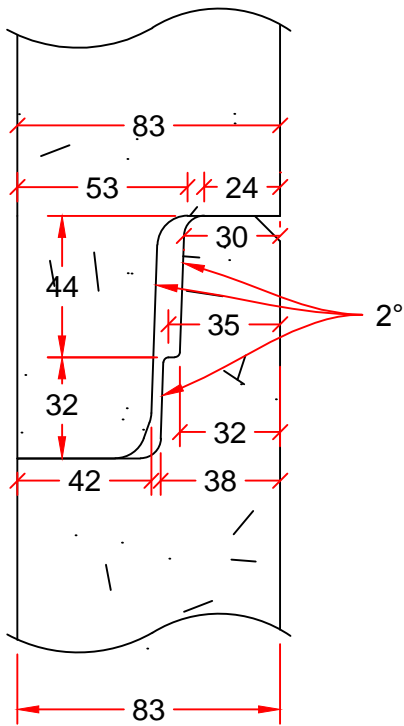

PIPE DETAIL

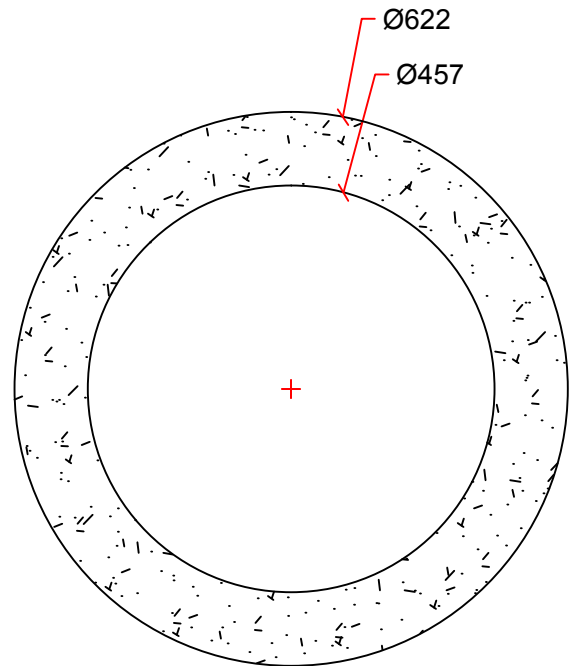

JOINT DETAIL



SECTION DETAIL

DRAWN BY:	SAM HAN	Ø450mm X 1.25m STRAIGHT WALL PIPE	 2494 FERRIER ST. WINNIPEG, MB. PH: 204 334-4300 FAX: 204 334-7957
SCALE:	NTS		
DATE:	NOVEMBER 10, 2015	DIMENSIONS IN mm	
DRAWING #:	Ø450mm X 1.25m T&G PIPE	APPROXIMATE MASS: 413 kg	
REVISION #:	REV. 1		
CHECKED BY:	TYSON DYCK		